

THE BASICS

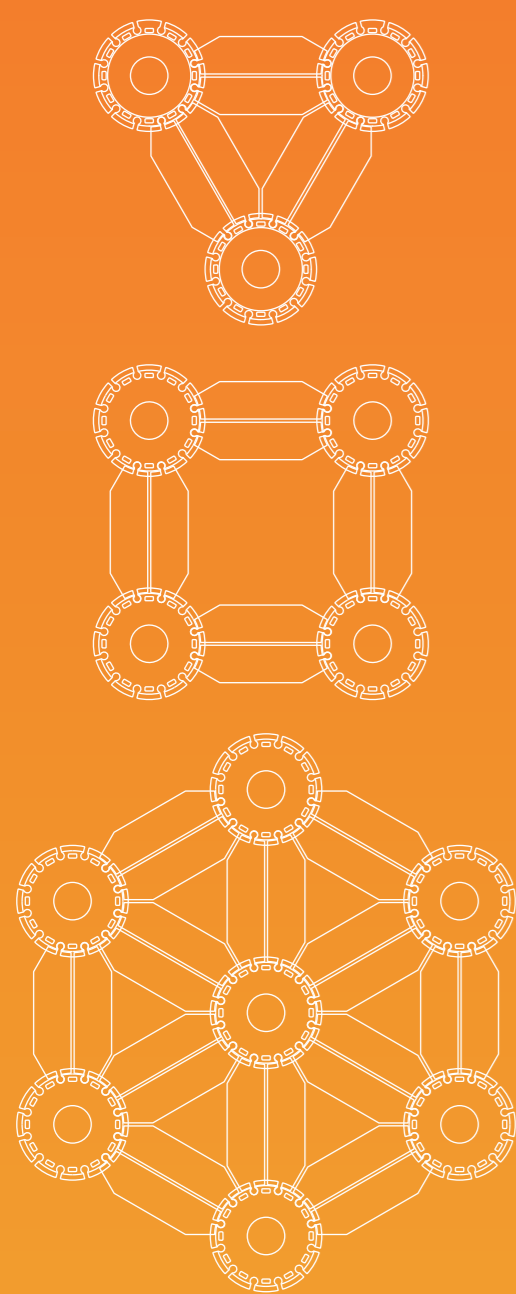

SET POLARITIES

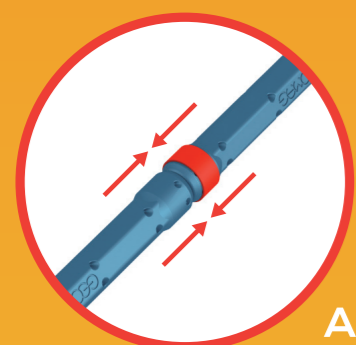

A
ATTRACTION = NO

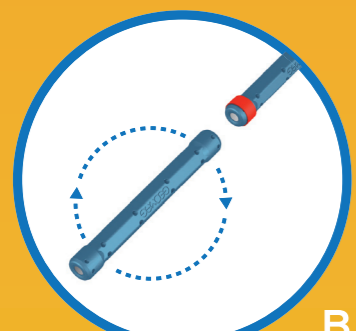

B
ROTATE

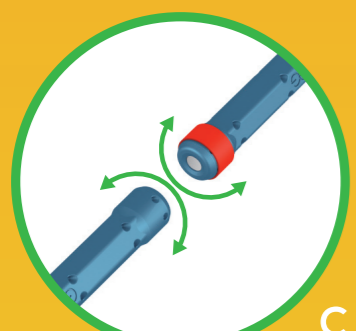

C
REPULSION = OK

1-6 MODEL 2

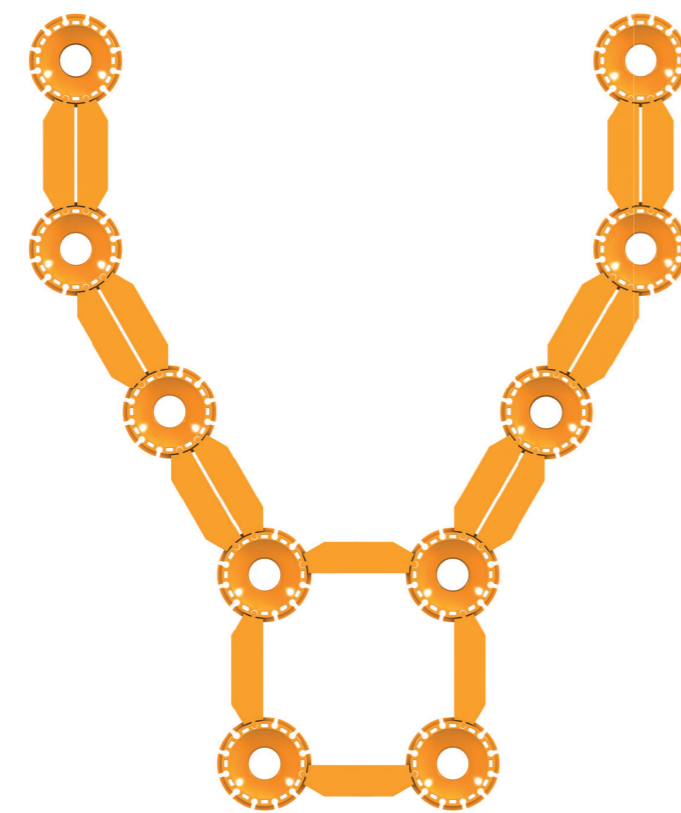
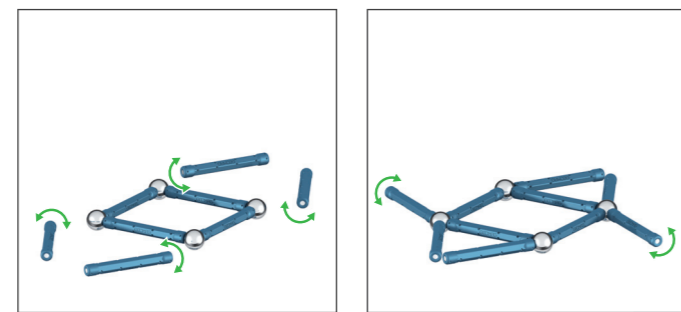

2-6

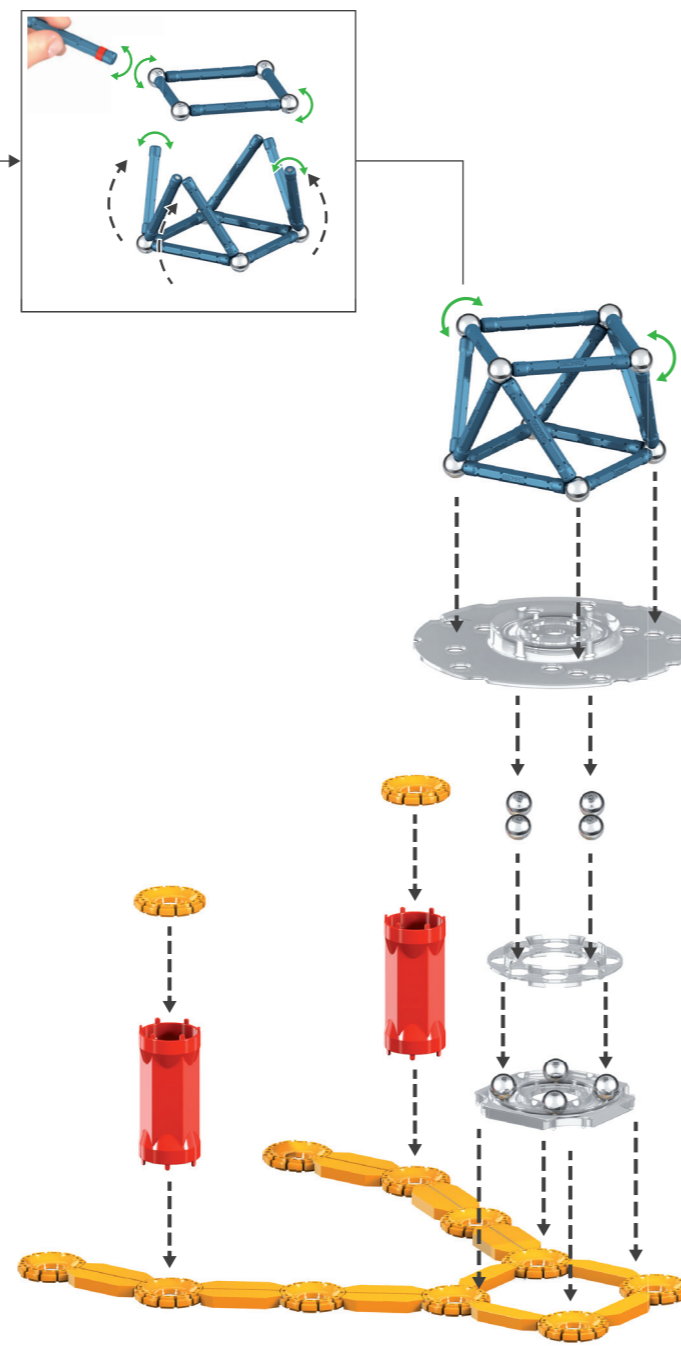

3-6

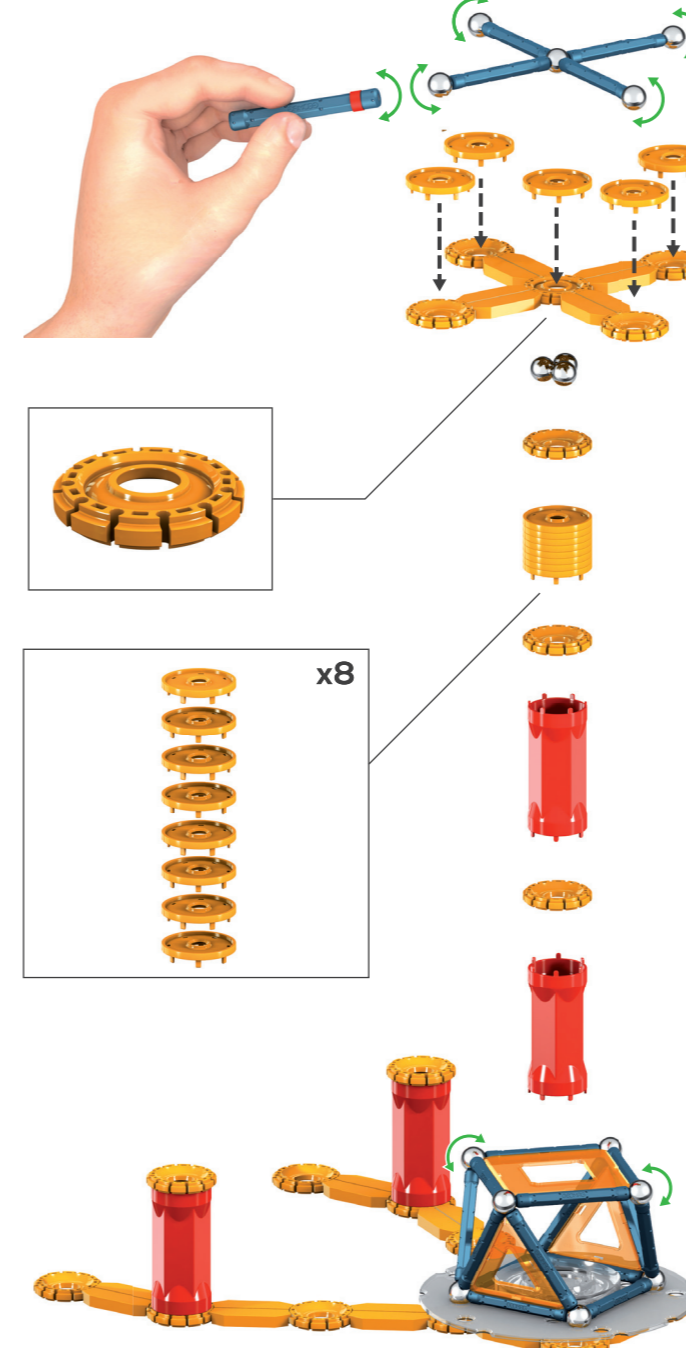

4-6

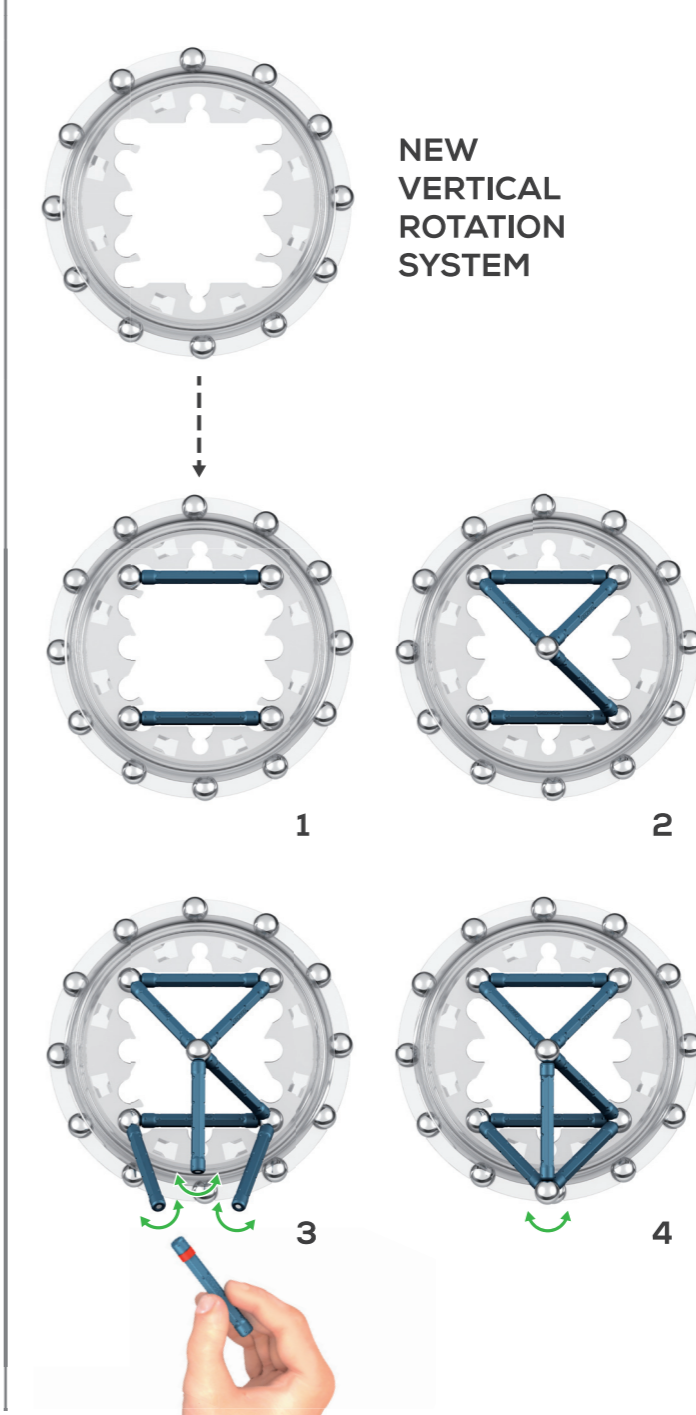

5-6

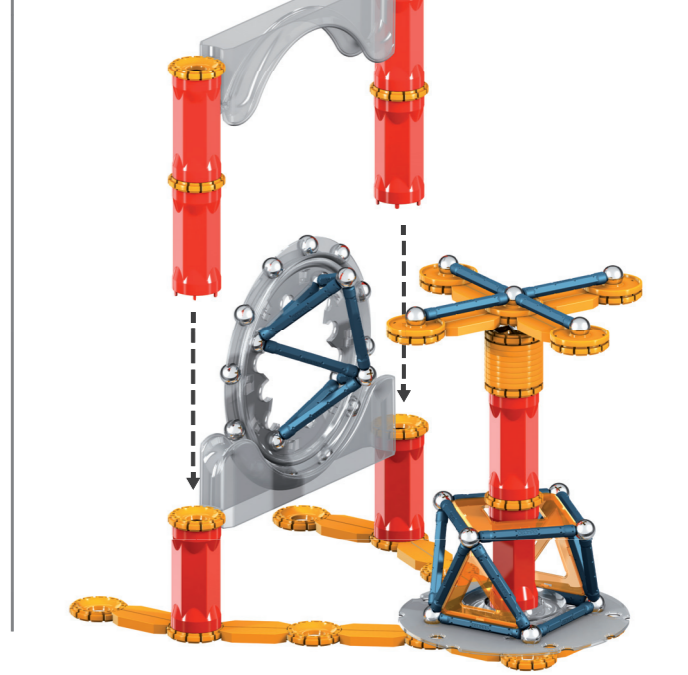

6-6

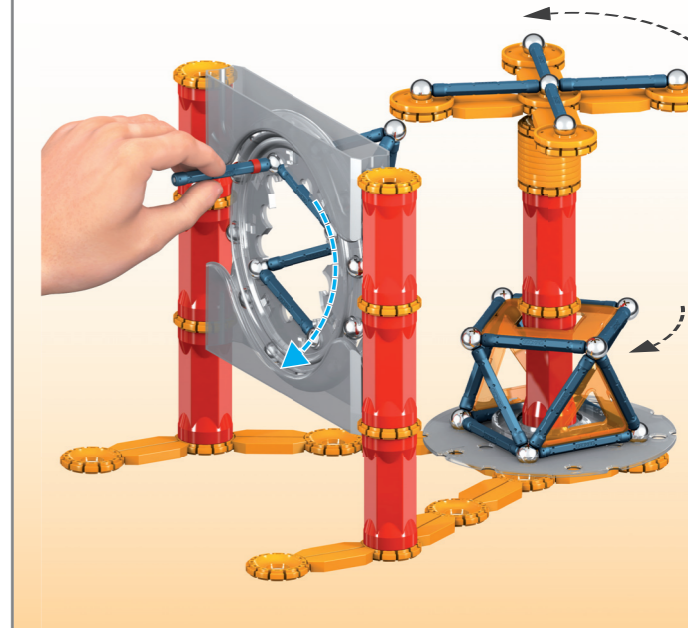

1-6 MODEL 3

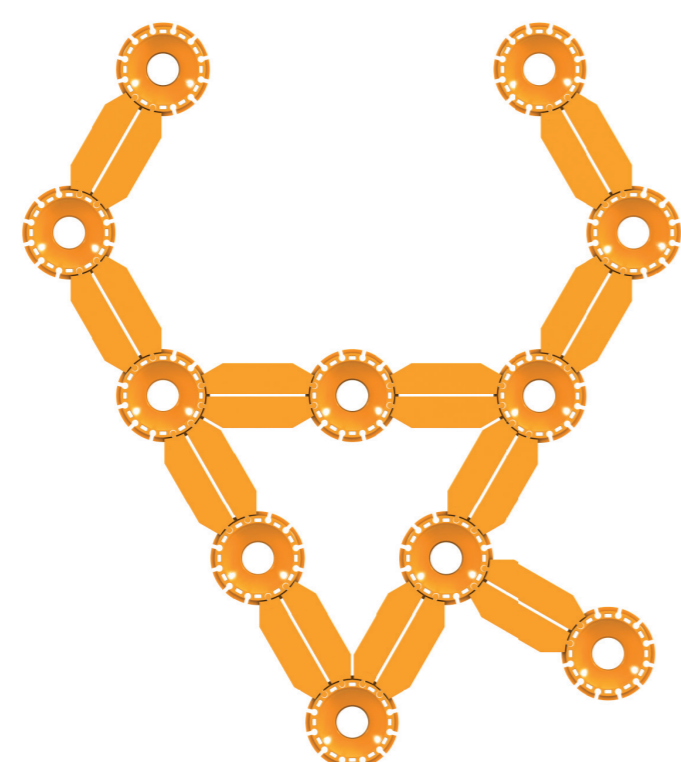

2-6

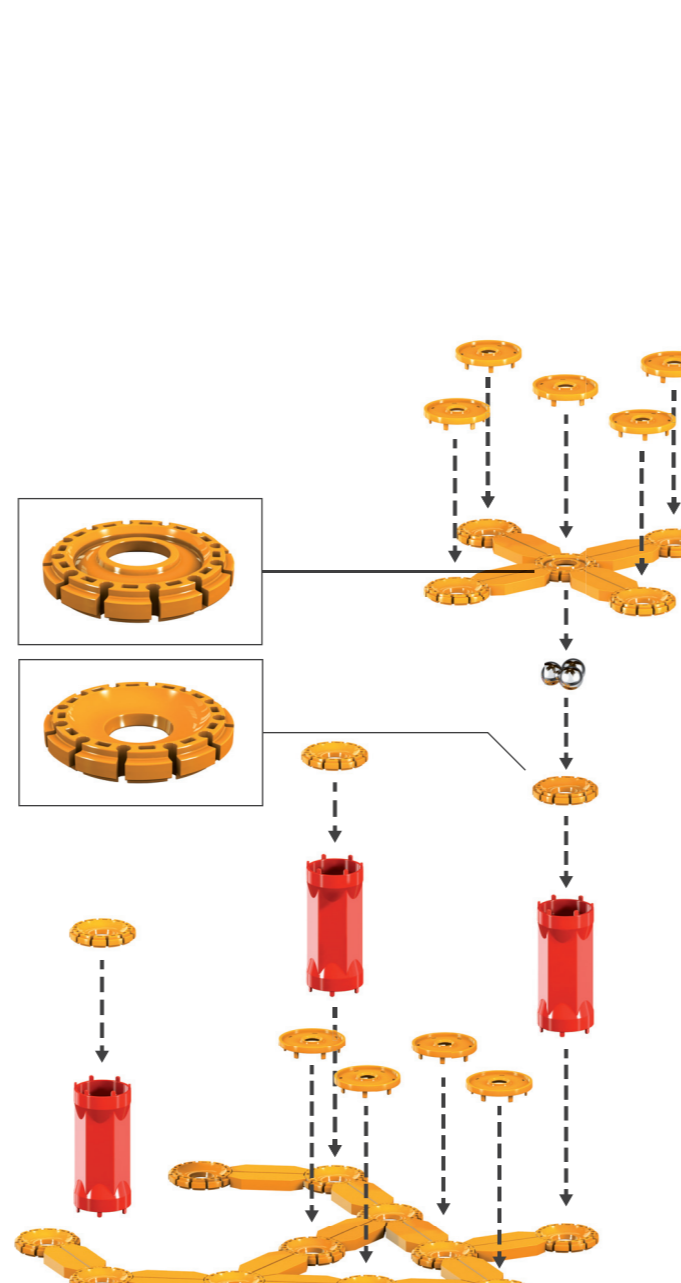

3-6

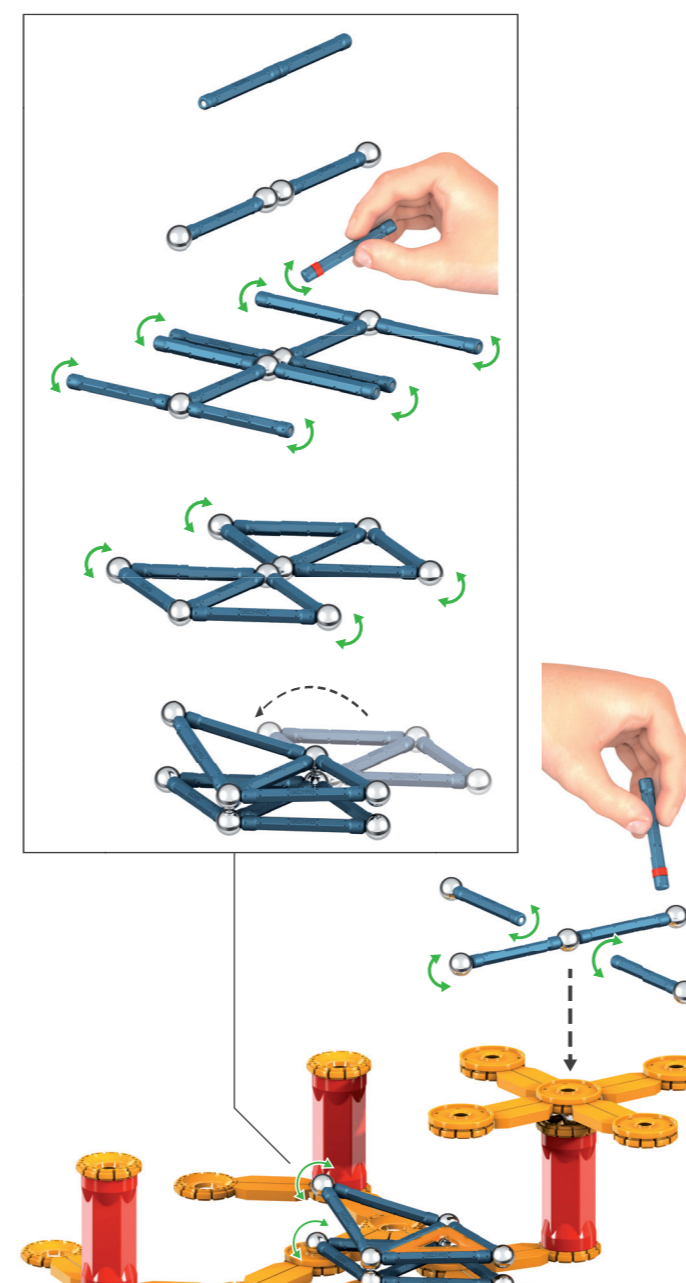

4-6

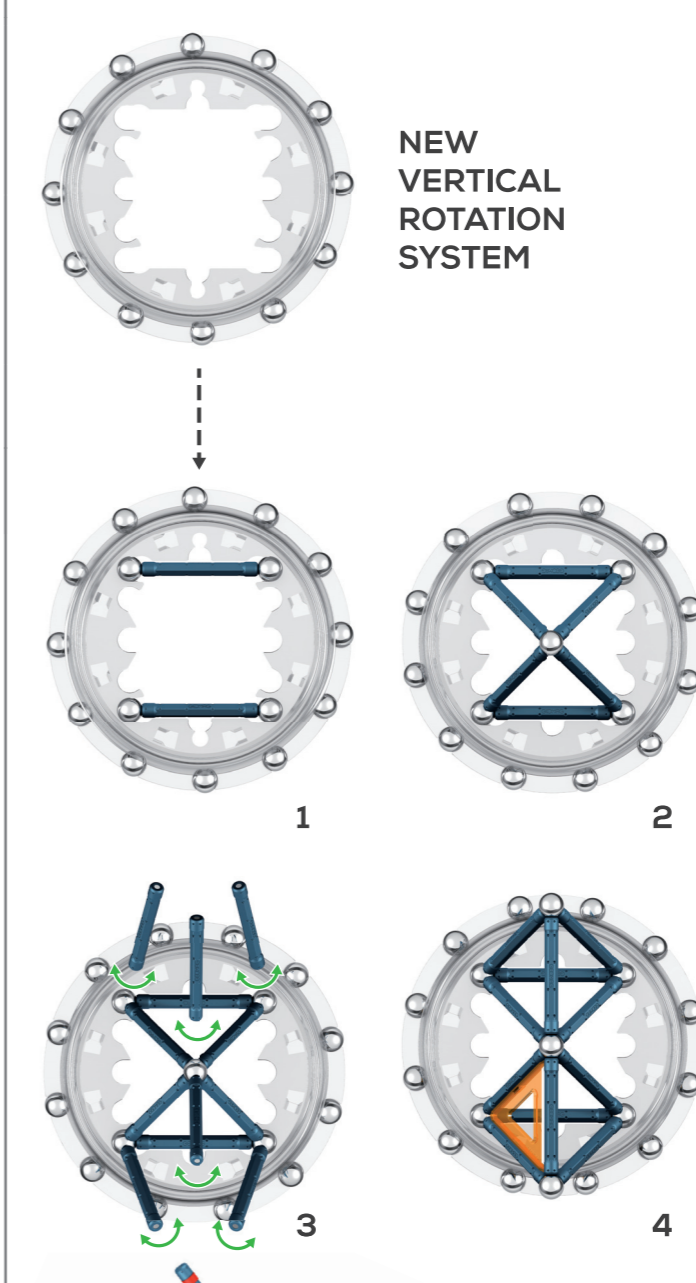

5-6



6-6

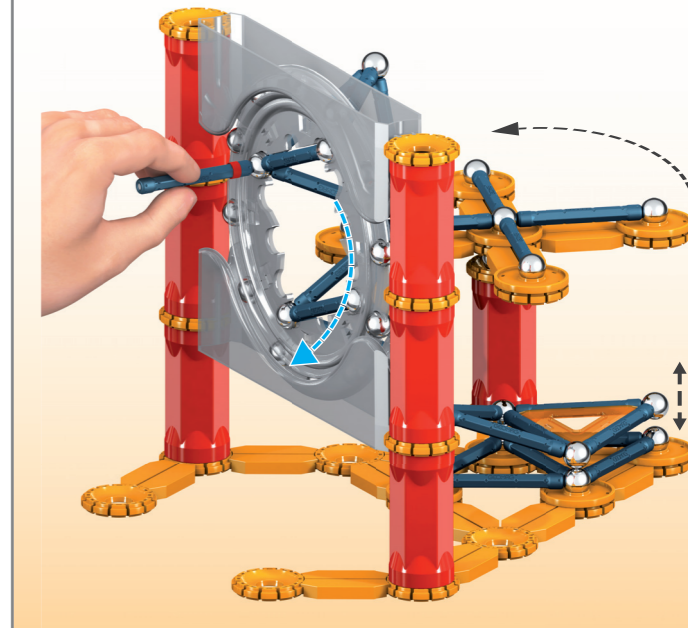

NEW VERTICAL ROTATION SYSTEM

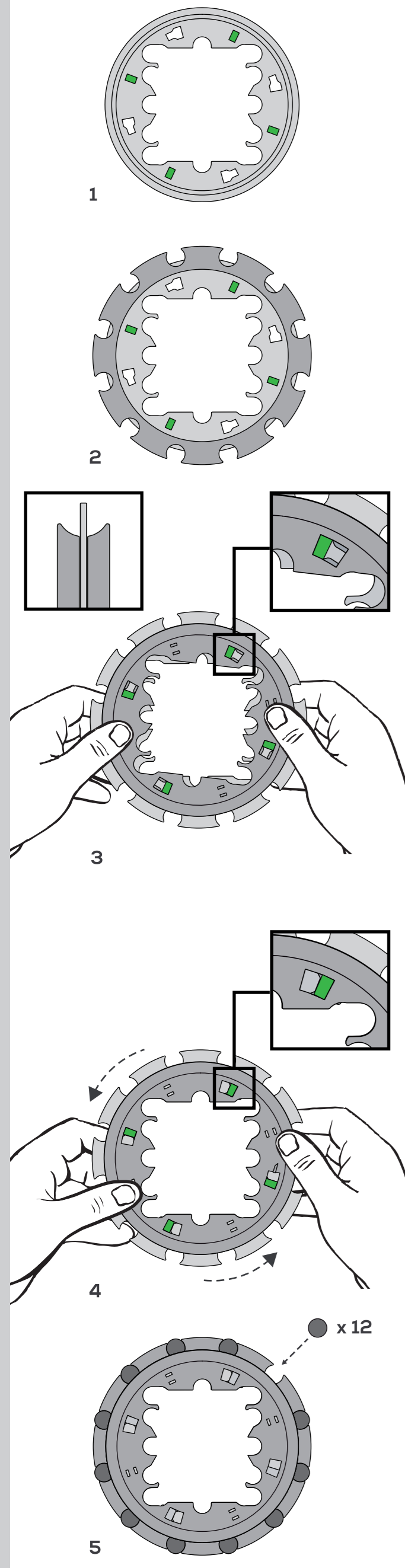

1-7 MODEL 1

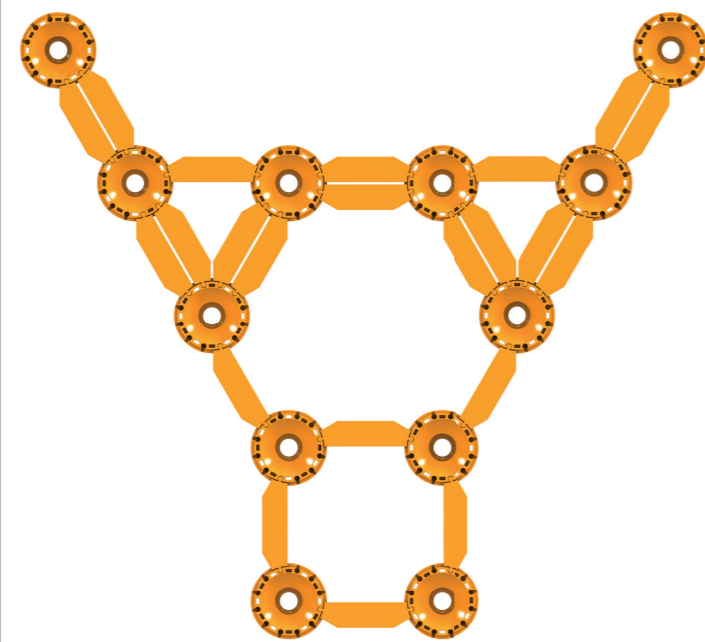

2-7

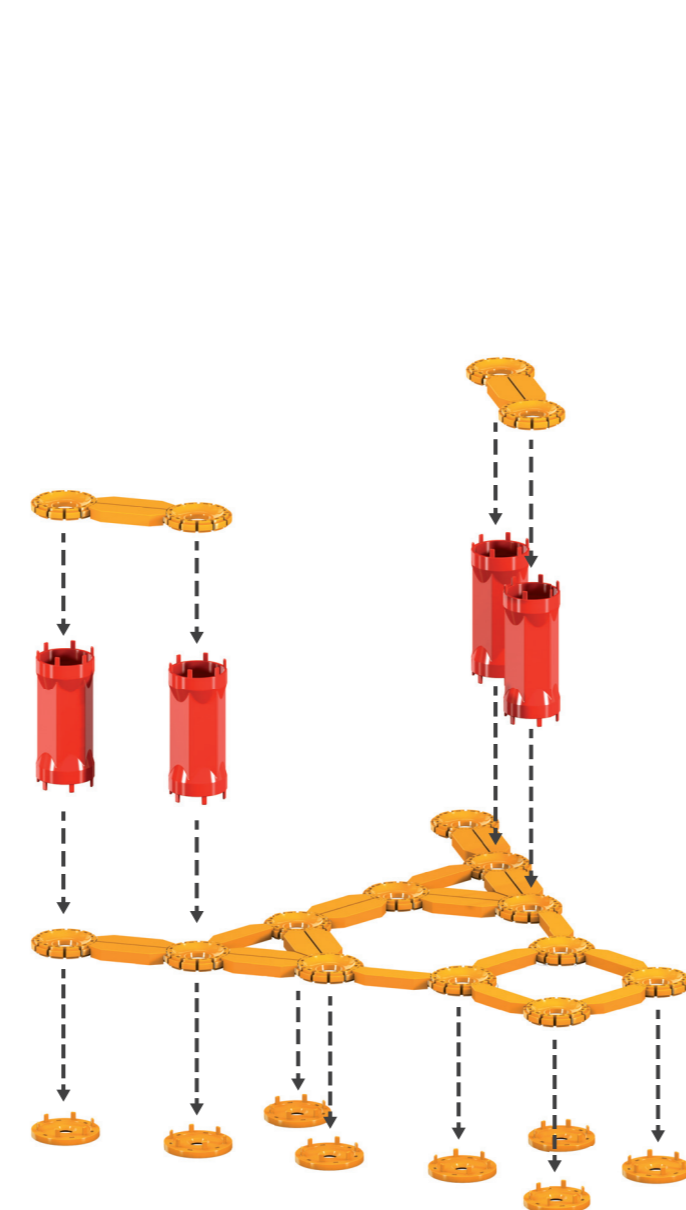

3-7

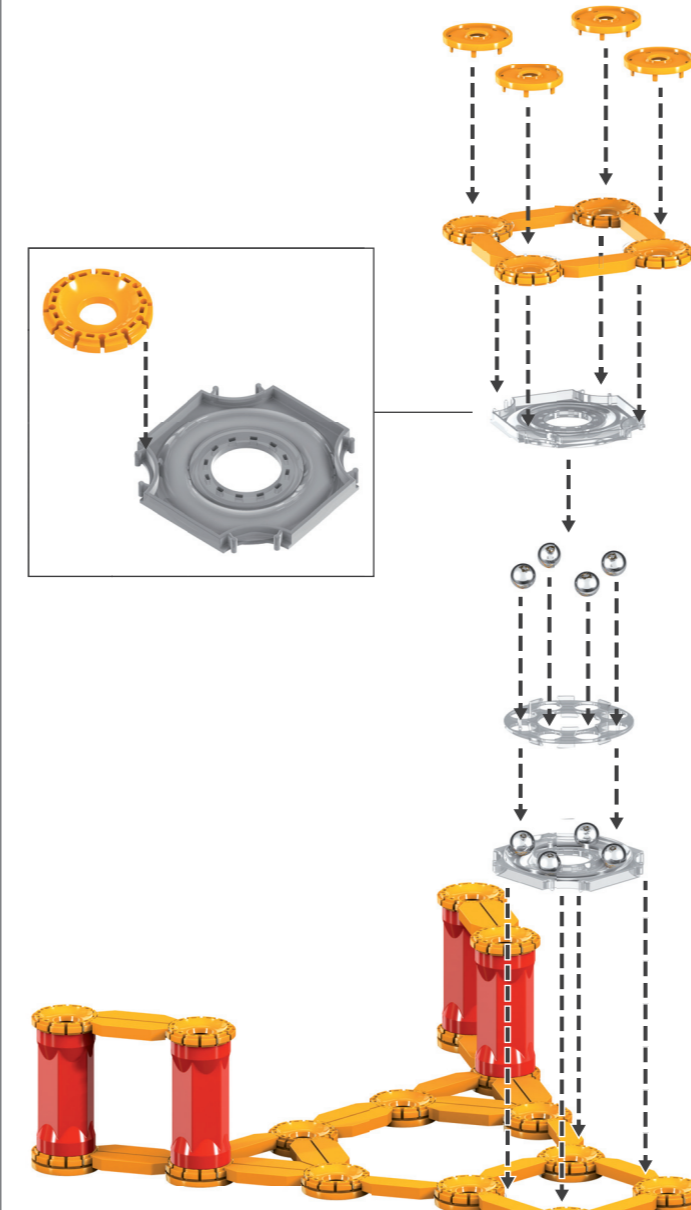

4-7

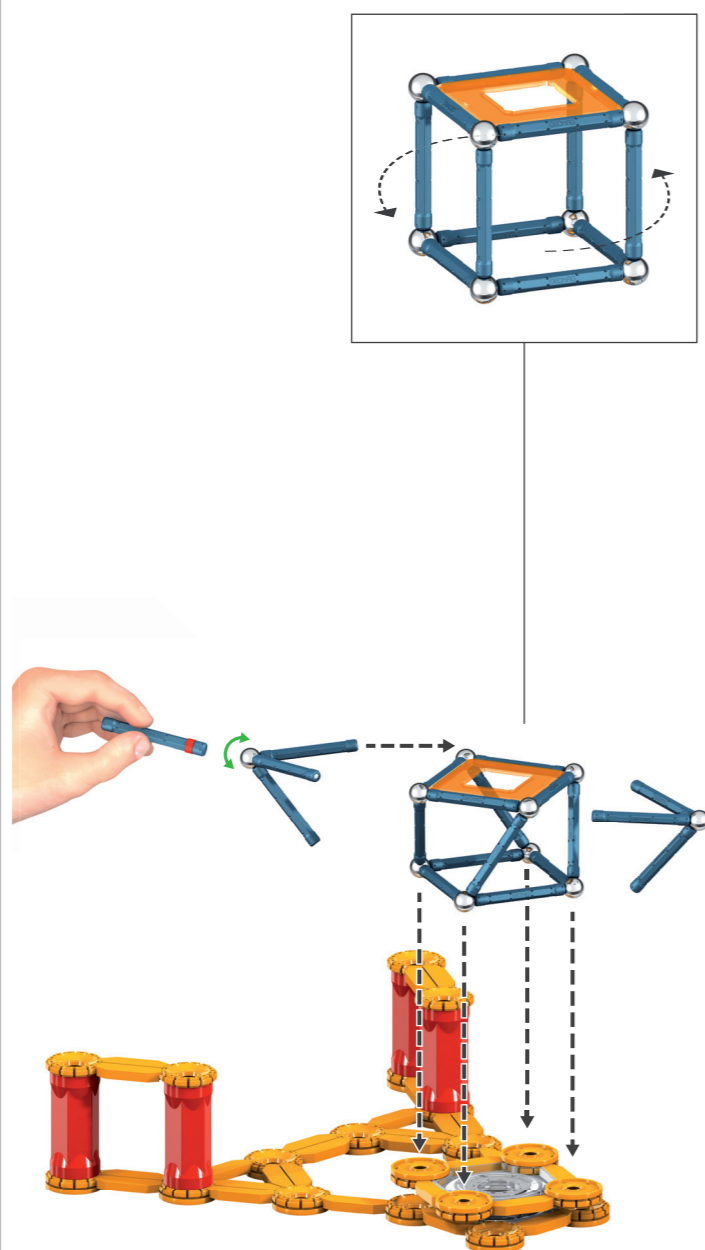

5-7

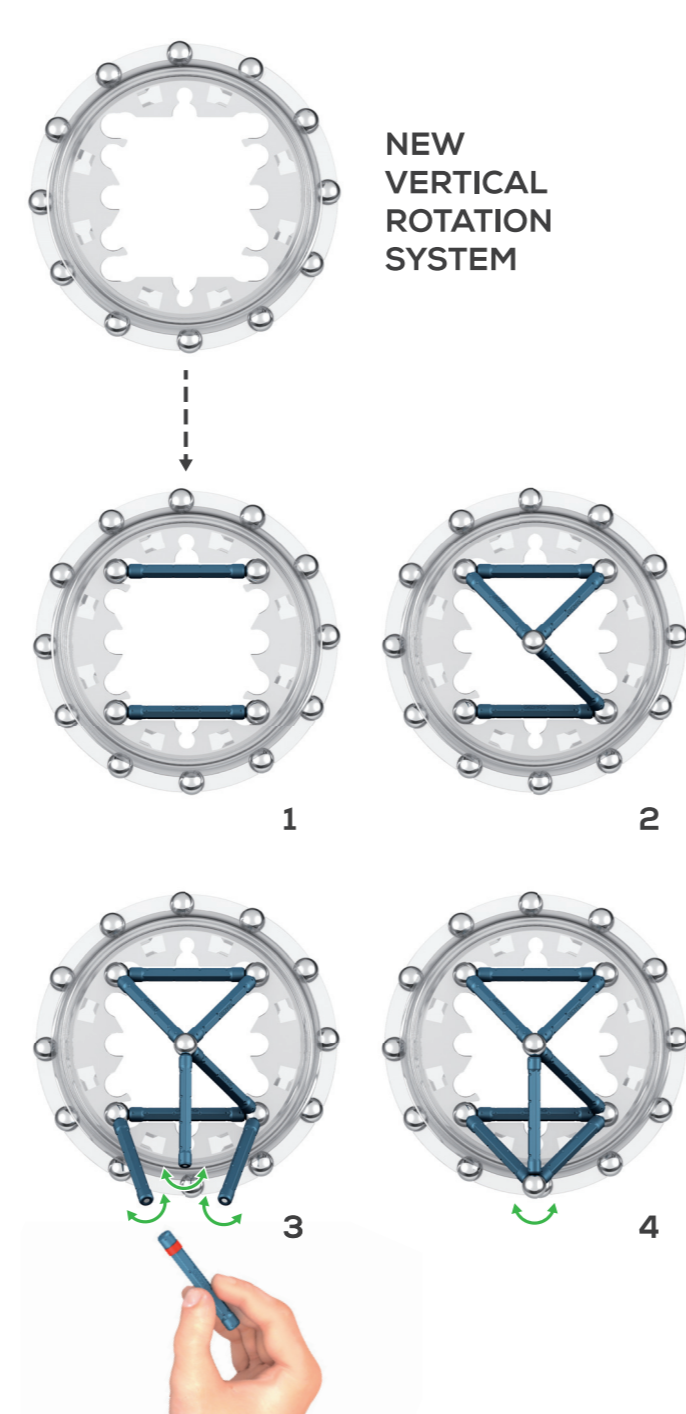

6-7

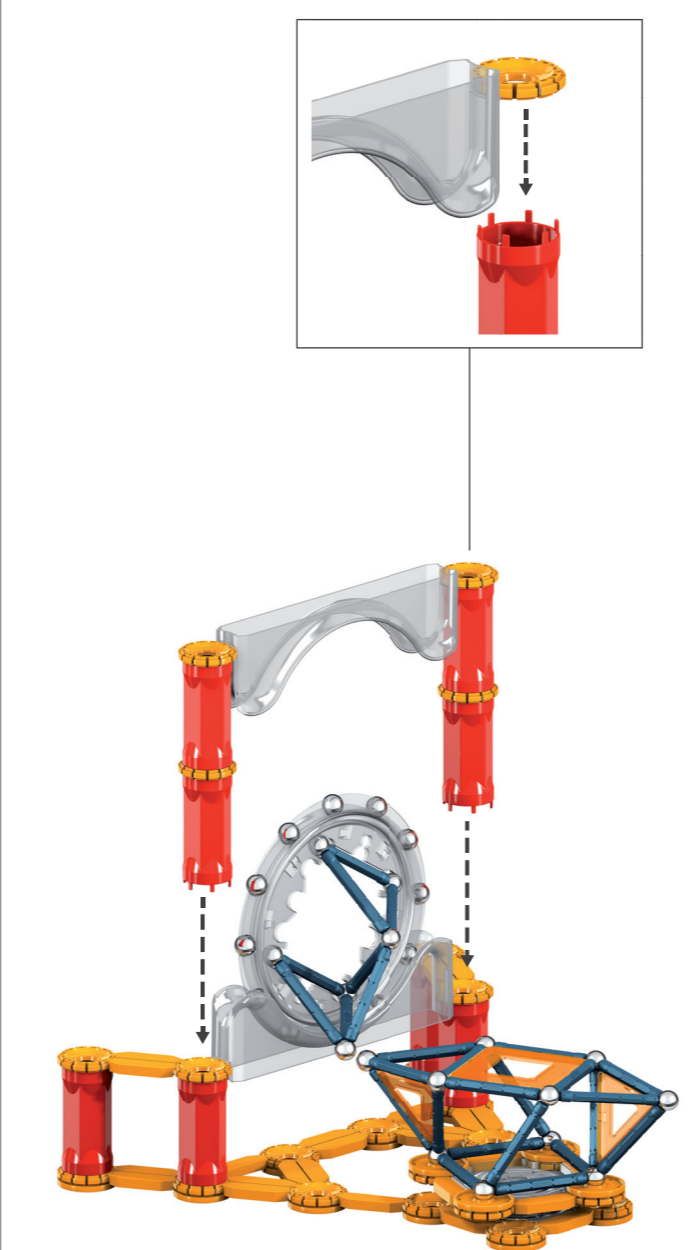

7-7

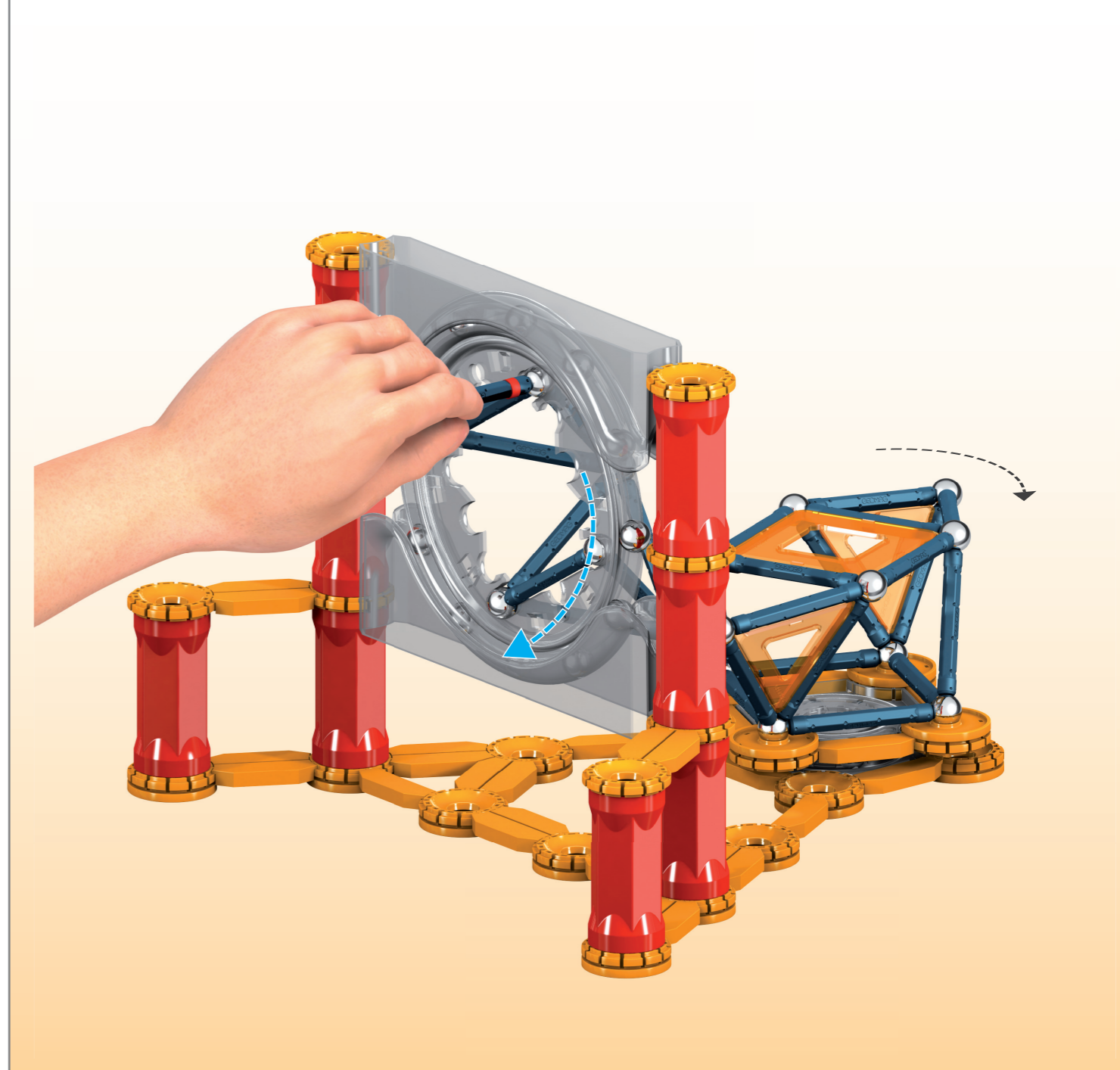

GEOMAG™

www.geomagworld.com



MAGNETIC CONSTRUCTION



Manufactured by:
GEOMAGWORLD SA
Via Roncaglia, 15 - CH 6883 Novazzano, Switzerland.
Geomag is a registered trademark. All Rights Reserved.

MP390.724.00

GEOMAG™

MECHANICS

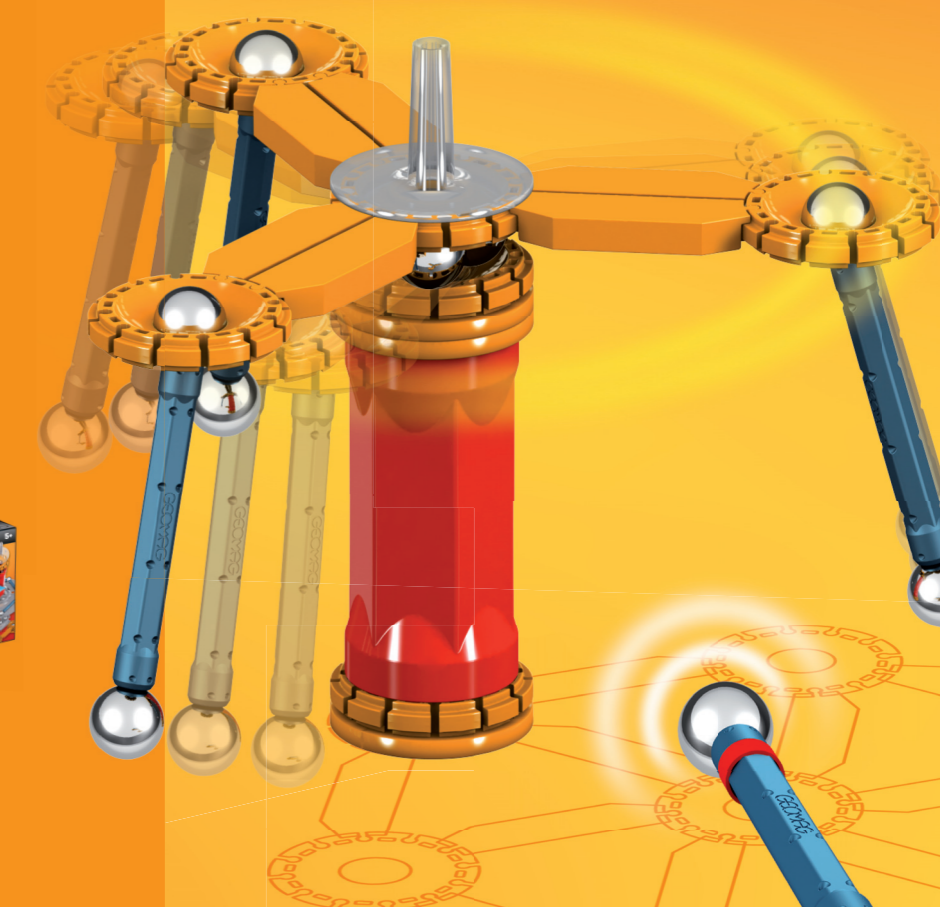

INSTRUCTIONS ITEM 724

WARNING:
CHOKING HAZARD
Toy Contains Small Parts and Marbles.
Not for children under 3 years.